

3 WAY LARGE TOYOTA SWITCH BRACKET

Dimension Diagram

Dimensions:

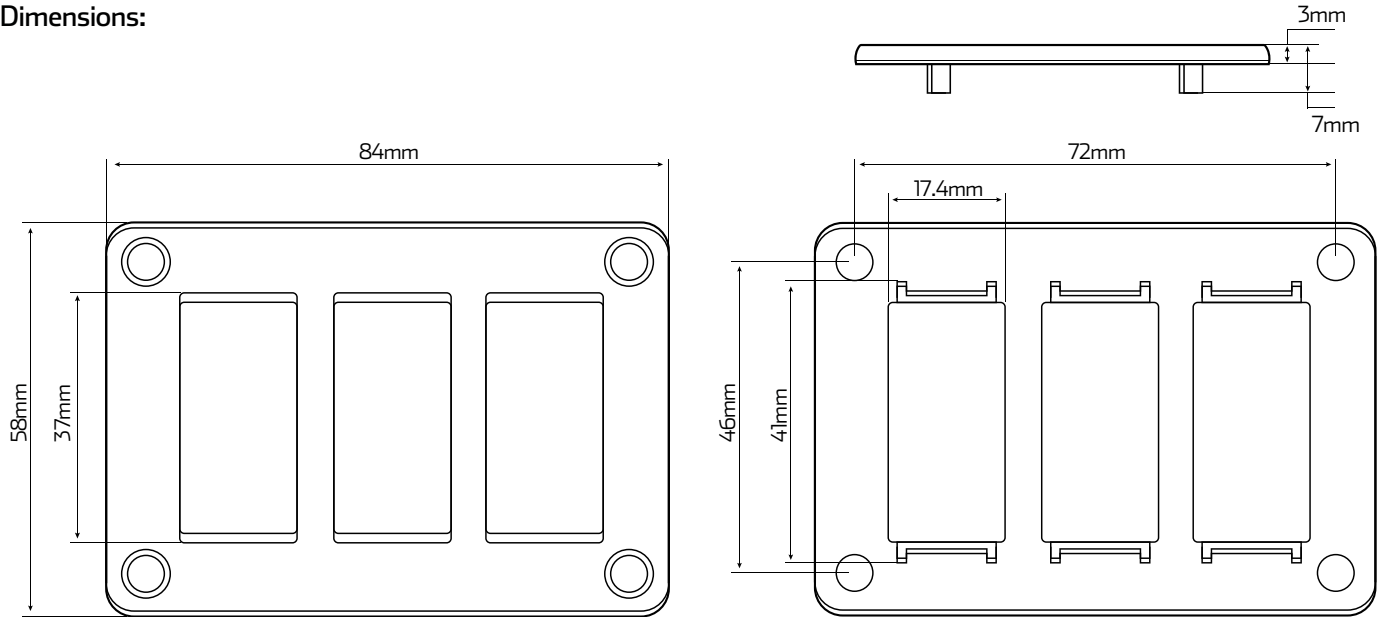

*To avoid warranty issues QVEE recommends our products are fitted by a qualified Auto Electrician.